

Q60LAF Series Laser Adjustable-Field Sensors



Datasheet

Long-Range Self-Contained Adjustable-Field Laser Sensors



- Long-range adjustable-field background suppression sensor detects objects within a defined sensing field, and ignores objects located beyond the sensing field cutoff
- Powerful visible red laser sensing beam, class 1 and class 2 models available
- Two-turn, logarithmic cutoff point adjustment for easy setting of cutoff point at long range; rotating pointer indicates relative cutoff point setting
- Easy push-button or remote programming of light/dark operate and output timing; continuous status indicators verify all settings at a glance
- Output ON and/or OFF delays adjustable from 8 milliseconds to 16 seconds
- Tough ABS/polycarbonate blend housing is rated IEC IP67; NEMA 6
- Models available for 10 to 30 V dc operation or universal voltage (12 to 250 V dc or 24 to 250 V ac, 50/60 Hz)



WARNING: Not To Be Used for Personnel Protection

Never use this device as a sensing device for personnel **protection**. Doing so could lead to serious injury or death. This device does not include the self-checking redundant circuitry necessary to allow its use in personnel safety applications. A sensor failure or malfunction can cause either an energized or de-energized sensor output condition.

Models

Class 1 Laser

Models	Cutoff Point	Cable	Supply Voltage	Output Type
Q60BB6LAF1400	Adjustable: 200 mm to 1400 mm (8 in to 55 in)	5-wire 2 m (6.5 ft)	10 V dc to 30 V dc	Bipolar NPN/PNP
Q60BB6LAF1400Q		5-pin Euro-style QD		
Q60BB6LAF1400QP		5-pin Euro-style QD 150 mm (6 in)		
Q60VR3LAF1400		5-wire 2 m (6.5 ft)	Universal Voltage 12 V dc to 250 V dc or 24 V ac to 250 V ac	E/M Relay (SPDT), normally closed and normally open contacts
Q60VR3LAF1400Q1		4-pin Micro-style QD		E/M Relay (SPST), normally open contact

Class 2 Laser

Models	Cutoff Point	Cable ¹	Supply Voltage	Output Type
Q60BB6LAF2000	Adjustable: 200 mm to 2000 mm (8 in to 80 in)	5-wire 2 m (6.5 ft)	10 V dc to 30 V dc	Bipolar NPN/PNP
Q60BB6LAF2000Q		5-pin Euro-style QD		
Q60BB6LAF2000QP		5-pin Euro-style QD 150 mm (6 in)		
Q60VR3LAF2000		5-wire 2 m (6.5 ft)	Universal Voltage 12 V dc to 250 V dc or 24 V ac to 250 V ac	E/M Relay (SPDT), normally closed and normally open contacts
Q60VR3LAF2000Q1		4-pin Micro-style QD		E/M Relay (SPST), normally open contact

¹ To order the 9 m (30 ft) PVC cable model, add the suffix "W/30" to the cabled model number. For example, Q60BB6LAF1400 W/30. Models with a quick disconnect require a mating cordset.



Overview

The Q60LAF sensor is a full-featured adjustable-field sensor. These adjustable-field sensors are able to detect objects of relatively low reflectivity, while ignoring other objects in the background (beyond the cutoff point). The cutoff distance is mechanically adjustable, using the 2-turn adjustment screw on the top of the sensor. A rotating pointer indicates the relative cutoff position. The indicator moves clockwise to show increasing distance.

The collimated laser emitter produces a small, bright spot, allowing easy alignment and precision sensing of relatively small objects at long range.

Two push buttons (ON Delay and OFF Delay) are used to set the output delay options, to toggle between light and dark operate modes and to lock out the push buttons for security purposes. These functions also may be accomplished using the remote wire (available on some models).

Seven LED indicators show, during RUN mode, the sensor configuration and operating status. During Delay Configuration, 5 of the LEDs combine to form a single light bar that indicates relative ON or OFF delay time.

 Note: When an object approaches from the side, the most reliable sensing usually occurs when the line of approach is parallel to the sensing axis.

 Note: Sensing at closer than the minimum specified range is not guaranteed.

Features and Indicators

 Note: Outputs are active during on/off timing selection mode.

ON Delay

Steady Green: Run mode, ON delay is active

Flashing Green: ON Delay Selection mode is active

OFF Delay

Steady Green: Run mode, OFF delay is active

Flashing Green: OFF Delay Selection mode is active

5-Segment Light Bar

Indicates relative delay time during ON or OFF Delay Selection modes

Output Indicator

Steady Amber: Outputs are conducting

Steady Green: During ON/OFF Delay Selection modes

Dark Operate Indicator

Steady Green: Dark Operate is selected

Lockout Indicator

Steady Green: Buttons are locked out

Light Operate Indicator

Steady Green: Light Operate is selected

Signal Indicator

Steady Green: Sensor is receiving signal

Flashing Green: Marginal signal (1.0 to 2.25 excess gain)

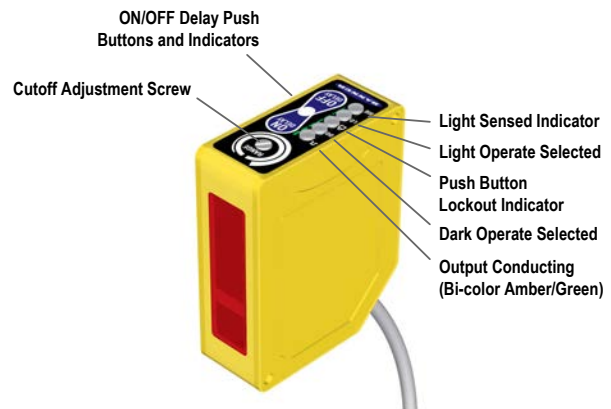

The indicators, above right, also function as a 5-segment light bar during delay selection modes

Adjustable-Field Sensing—Theory of Operation

The Q60LAF compares the reflections of its emitted light beam (E) from an object back to the sensor's two differently-aimed detectors R1 and R2 (see [Figure 1](#) on page 3). If the near detector (R1) light signal is stronger than the far detector (R2) light signal (see object A, closer than the cutoff distance), the sensor responds to the object. If the far detector (R2) light signal is stronger than the near detector (R1) light signal (see object B, object beyond the cutoff distance), the sensor ignores the object.

The cutoff distance for these sensors is adjustable. Objects lying beyond the cutoff distance are ignored, even if they are highly reflective. However, it is possible to falsely detect a background object, under certain conditions (see [Background Reflectivity and Placement](#) on page 4).

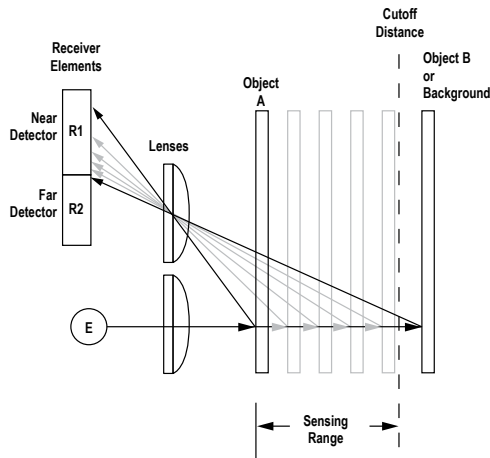

Figure 1. Adjustable field sensing concept

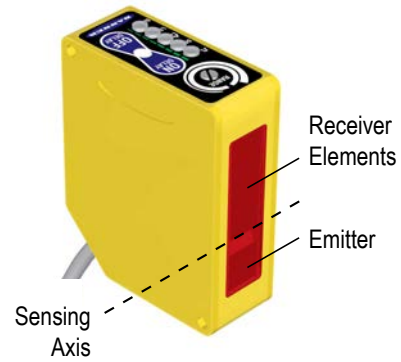
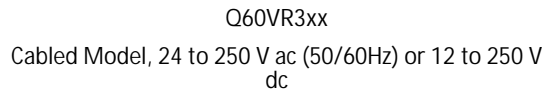
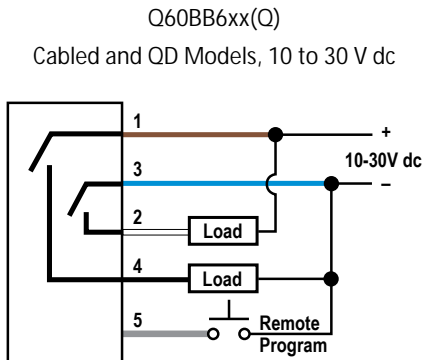

Figure 2. Sensing Axis

In the drawings and information provided in this document, the letters E, R1, and R2 identify how the sensor's three optical elements (Emitter "E", Near Detector "R1", and Far Detector "R2") line up across the face of the sensor. The location of these elements defines the sensing axis (see [Figure 2](#) on page 3). The sensing axis becomes important in certain situations, such as those illustrated in [Figure 7](#) on page 5 and [Figure 8](#) on page 5.

Installation

Wiring Diagrams



Key
1 = Brown
2 = White
3 = Blue
4 = Black
5 = Gray

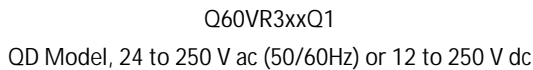

Key
1 = Red/Black
2 = Red/White
3 = Red
4 = Green

*NOTE: Connection of dc power is without regard to polarity.

Set the Cutoff Distance

The cutoff distance for Q60LAF sensors can be adjusted between 200 mm and 1400 mm (8 in to 55 in) for Class 1 laser models, and between 200 mm and 2000 mm (8 in to 80 in) for Class 2 laser models.

To maximize contrast, position the lightest possible background to be used, at the closest position it will come to the sensor during use. Using a small screwdriver in the adjustment screw, adjust the cutoff distance until the threshold is reached and the green Light Sensed indicator changes state. If the indicator never turns ON, the background is beyond the maximum sensing cutoff and will be ignored. Note the position of the rotating cutoff position indicator at this position. Then repeat the procedure, using the darkest target, placed in its most distant position for sensing. Adjust the cutoff so that the indicator is midway between the two positions.

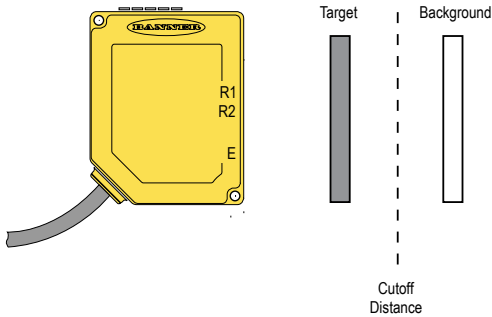

Figure 3. Set the cutoff distance approximately midway between the farthest target and the closest background

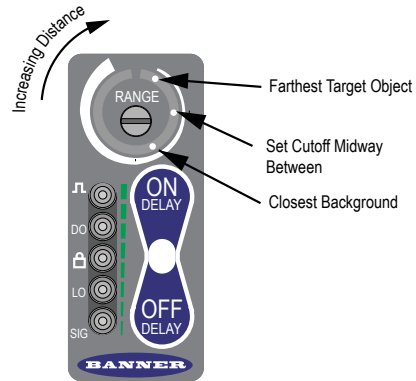

Figure 4. Setting the cutoff distance

Note: Setting the cutoff distance adjustment screw to its maximum clockwise position places the receiver lens directly in front of the receiver elements and results in the Q60 performing as a long-range diffuse sensor.

Sensing Reliability

For highest sensitivity, the sensor-to-object distance should be such that the object will be sensed at or near the point of maximum excess gain. The excess gain curves show excess gain versus sensing distance for 200 mm, 1200 mm, and 2 m cutoffs. Maximum excess gain for a 200 mm cutoff occurs at a lens-to-object distance of about 150 mm, and for a 2 m cutoff, at about 500 mm. The background must be placed beyond the cutoff distance. Following these two guidelines makes it possible to detect objects of low reflectivity, even against close-in reflective backgrounds.

Background Reflectivity and Placement

Avoid mirror-like backgrounds that produce specular reflections. A false sensor response occurs if a background surface reflects the sensor's light more to the near detector (R1) than to the far detector (R2). The result is a false ON condition (Figure 5 on page 4). Correct this problem by using a diffusely reflective (matte) background, or angling either the sensor or the background (in any plane) so the background does not reflect light back to the sensor (Figure 6 on page 4). Position the background as far beyond the cutoff distance as possible.

An object beyond the cutoff distance, either stationary (and when positioned as shown in Figure 7 on page 5), or moving past the face of the sensor in a direction perpendicular to the sensing axis, may cause unwanted triggering of the sensor if more light is reflected to the near detector than to the far detector. Correct the problem by rotating the sensor 90° (Figure 8 on page 5). The object then reflects the R1 and R2 fields equally, resulting in no false triggering. A better solution, if possible, may be to reposition the object or the sensor.

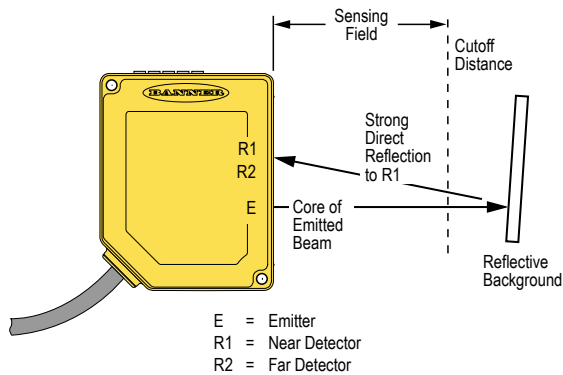

Figure 5. Reflective Background - Problem

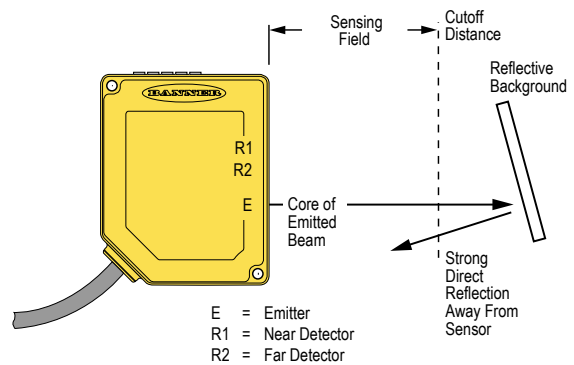
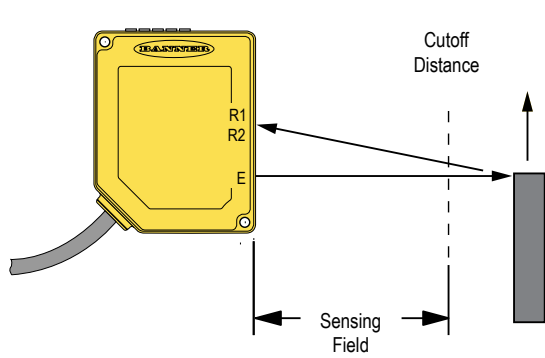
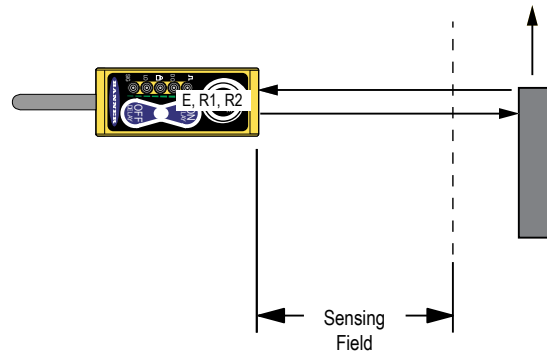

Figure 6. Reflective Background - Solution



A reflective background object in this position or moving across the sensor face in this axis and direction may cause a false sensor response.

Figure 7. Object Beyond Cutoff - Problem



A reflective background object in this position or moving across the sensor face in this axis is ignored.

Figure 8. Object Beyond Cutoff - Solution

Color Sensitivity

The effects of object reflectivity on cutoff distance, though small, may be important for some applications. It is expected that at any given cutoff setting, the actual cutoff distance for lower reflectance targets is slightly shorter than for higher reflectance targets. This behavior is known as color sensitivity.

These excess gain curves were generated using a white test card of 90% reflectance. Objects with reflectivity of less than 90% reflect less light back to the sensor, and thus require proportionately more excess gain in order to be sensed with the same reliability as more reflective objects. When sensing an object of very low reflectivity, it may be especially important to sense it at or near the distance of maximum excess gain.

The percentage of deviation indicates a change in the cutoff point for either 18% gray or 6% black targets, relative to the cutoff point set for a 90% reflective white test card.

For example, the cutoff point decreases 10% for a 6% reflectance black target when the cutoff point is adjusted for 1700 mm (67 in) using a 90% reflectance white test card. In other words, the cutoff point for the black target is 1530 mm (60 in) for this setting.

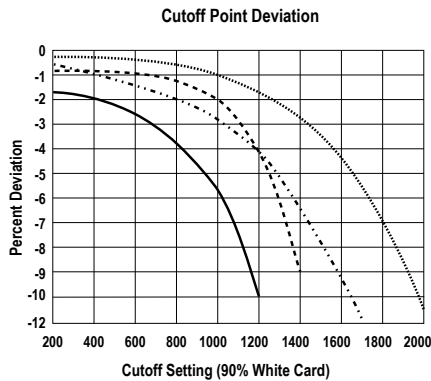
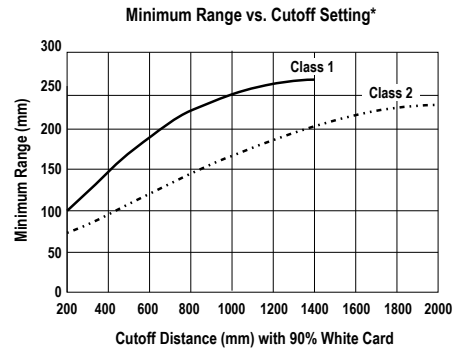

Figure 9. Cutoff Point Deviation



*NOTE: Minimum range is independent of target reflectivity

Figure 10. Q60 Minimum Range Versus Cutoff Setting

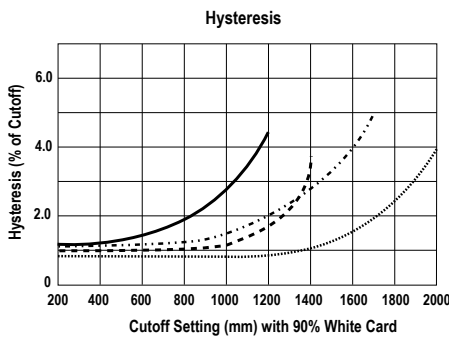

Figure 11. Hysteresis

Class 1 Laser 18% Gray Card - - - - -
 6% Black Card - - - - -
 Class 2 Laser 18% Gray Card
 6% Black Card - · - · - ·

Configuring a Sensor

Set the Output Delay

The output of the Q60LAF sensor may be delayed between 0.008 and 16 seconds, in any of 72 increments. Delay is indicated on the 5-segment light bar using single LED segments or combinations of them, in varying stages of intensity.

To set a delay, single-click the appropriate button or pulse the remote wire to enable the process (as described in the following procedures). Then use the + or - button or the appropriate remote wire pulse procedure to increase or decrease the delay (single-click adjusts the delay by one step at a time, and holding the button in provides a rapid increase/decrease).

Major increments, displayed by a single full-intensity LED, are shown:

Step #	Delay Time	LED Status
0	No Delay	
8	0.062 second	
24	0.250 second	
40	1.00 second	
56	4.0 seconds	
72	16 seconds	

Increase or Decrease the ON Delay

T = 40 – 800 ms
 Press and Hold > 800 ms unless otherwise noted

Increase the ON Delay—4-second time-out

	Enter ON Delay Setup	Enable Delay Increment	Step Increment	Rapid Increment
Push Button		N/A		
Remote Input				



Decrease the ON Delay—4-second time-out

	Enter ON Delay Setup	Enable Delay Decrement	Step Decrement	Rapid Decrement
Push Button		N/A		
Remote Input				



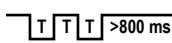
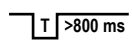
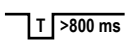
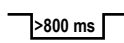

Increase or Decrease the OFF Delay

T = 40 – 800 ms
 Press and Hold > 800 ms unless otherwise noted

Increase the OFF Delay—4-second **time-out**

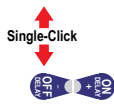
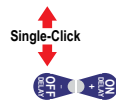

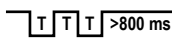
	Enter OFF Delay Setup	Enable Delay Increment	Step Increment	Rapid Increment
Push Button		N/A		
Remote Input				

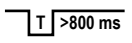
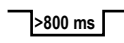
Decrease the OFF Delay—4-second **time-out**

	Enter OFF Delay Setup	Enable Delay Decrement	Step Decrement	Rapid Decrement
Push Button		N/A		
Remote Input				

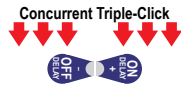

Select Light Operate or Dark Operate

Select Light Operate or Dark Operate mode using the two push buttons or a triple-pulse of the remote line to toggle between the selections.

	LO/DO Toggle
Push Button	
Remote Input	

Lock the Push **Buttons**

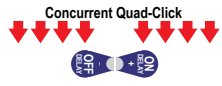
For security, the push buttons can be locked out using either the remote line or the push buttons themselves.

	Push Button Lockout Toggle
Push Button	
Remote Input	

Enable or Disable the Laser

The laser is disabled after remote line is held low for 800 ms and will remain disabled until remote line is released.

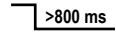

Note: 500 ms maximum delay after laser is enabled; outputs will default to "No Light" state.

	Disable the Laser
Push Button	Not available
Remote Input	

Laser Description and Safety Information



CAUTION: Do Not Disassemble for Repair

This device contains no user-serviceable components. Do not attempt to disassemble for repair. Use of controls or adjustments or performance of procedures other than those specified herein may result in hazardous radiation exposure. A defective unit must be returned to the manufacturer.

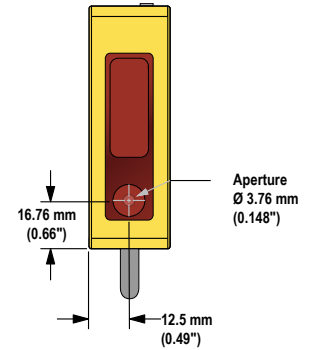

Figure 12. Laser Aperture Location

Class 1 Lasers

Class 1 lasers are lasers that are safe under reasonably foreseeable conditions of operation, including the use of optical instruments for intrabeam viewing.

Reference IEC 60825-1:2001, Section 8.2.



Class 2 Lasers

Class 2 lasers are lasers that emit visible radiation in the wavelength range from 400 nm to 700 nm, where eye protection is normally afforded by aversion responses, including the blink reflex. This reaction may be expected to provide adequate protection under reasonably foreseeable conditions of operation, including the use of optical instruments for intrabeam viewing.

Reference IEC 60825-1:2001, Section 8.2.

Class 2 Laser Safety Notes

Low-power lasers are, by definition, incapable of causing eye injury within the duration of a blink (aversion response) of 0.25 seconds. They also must emit only visible wavelengths (400 to 700 nm). Therefore, an ocular hazard may exist only if individuals overcome their natural aversion to bright light and stare directly into the laser beam.



For Safe Laser Use (Class 1 or Class 2):

- Do not stare at the laser.
- Do not point the laser at a person's eye.
- Mount open laser beam paths either above or below eye level, where practical.
- Terminate the beam emitted by the laser product at the end of its useful path.

Specifications

Supply Voltage and Current

Q60BB6LAF models: 10 to 30 V dc (10% maximum ripple) at less than 50 mA exclusive of load
 Q60VR3LAF Universal models: 12 to 250 V dc or 24 to 250 V ac, 50/60 Hz
 Input power: 1.5 W maximum

Supply Protection Circuitry

Protected against reverse polarity and transient voltages
 The dc wiring for model Q60VR3 is without regard to polarity

Output Configuration

Q60BB6LAF models: Bipolar; one NPN (current sinking) and one PNP (current sourcing) open-collector transistor
 Q60VR3LAF cabled model: E/M Relay (SPDT), normally closed and normally open contacts
 Q60VR3LAFQ1 (QD) model: E/M Relay (SPST), normally open contact

Output Rating—Q60BB6LAF models

150 mA maximum each output @ 25 °C
 Off-state leakage current: < 5 µA @ 30 V dc
 Output saturation NPN: < 200 mV @ 10 mA and < 1 V @ 150 mA
 Output saturation PNP: < 1 V at 10 mA; < 1.5 V at 150 mA

Output Rating—Q60VR3LAF Universal models

Minimum voltage and current: 5 V dc, 10 mA
 Mechanical life of relay: 50,000,000 operations
 Electrical life of relay at full resistive load: 100,000 operations
 Maximum switching power (resistive load):
 Cabled models: 1250 VA, 150 W
 QD models: 750 VA, 90 W

Maximum switching voltage (resistive load):

Cabled models: 250 V ac, 125 V dc
 QD models: 250 V ac, 125 V dc

Maximum switching current (resistive load):

Cabled models: 5 A @ 250 V ac, 5 A @ 30 V dc derated to 200 mA @ 125 V dc
 QD models: 3 A @ 250 V ac, 3 A @ 30 V dc derated to 200 mA @ 125 V dc

Output Protection Circuitry

Q60BB6LAF models: Protected against continuous overload or short circuit of outputs
 All models: Protected against false pulse on power-up



Note: 1 second maximum delay at power up (outputs do not conduct during this time)

Output Response Time

Q60BB6LAF models: 2 milliseconds ON and OFF
 Q60VR3LAF Universal models: 15 milliseconds ON and OFF

Repeatability

500 microseconds

Sensing Hysteresis

See [Figure 11](#) on page 5

Laser Characteristics

Spot Size: approximately 4 × 2 mm throughout range (collimated beam)
 Angle of Divergence: 5 milliradians



Note: Contact Banner Engineering for a custom laser spot size.

Adjustments

Slotted, geared, 2-turn, cutoff range adjustment screw (mechanical stops on both ends of travel)
 2 momentary push buttons: ON Delay (+) and OFF Delay (-); DC models also have a remote program wire
 ON Delay select: 8 ms to 16 seconds
 OFF Delay select: 8 ms to 16 seconds
 LO/DO select
 Push button lockout for security
 Laser Enable/Disable (remote wire only)

Construction

Housing: ABS polycarbonate blend
 Lens: Acrylic

Environmental Rating

IEC IP67; NEMA 6

Connections

Q60BB6LAF models: 2 m (6.5 ft) or 9 m (30 ft) attached cable, 5-pin Euro-style integral QD, or 5-pin Euro-style 150 mm (6 in) QD
 Q60VR3LAF Universal models: 2 m (6.5 ft) or 9 m (30 ft) attached cable, or 5-pin Micro-style 150 mm (6 in) QD

Operating Conditions

Temperature:

Q60BB6LAF models: -10 °C to +50 °C (+14 °F to +122 °F)
 Q60VR3LAF Universal models: -10 °C to +45 °C (+14 °F to +113 °F)

90% at +50 °C maximum relative humidity (non-condensing)

Required Overcurrent Protection



WARNING: Electrical connections must be made by qualified personnel in accordance with local and national electrical codes and regulations.

Overcurrent protection is required to be provided by end product application per the supplied table.

Overcurrent protection may be provided with external fusing or via Current Limiting, Class 2 Power Supply.

Supply wiring leads < 24 AWG shall not be spliced.

For additional product support, go to www.bannerengineering.com.

Supply Wiring (AWG)	Required Overcurrent Protection (Amps)
20	5.0
22	3.0
24	2.0
26	1.0
28	0.8
30	0.5

Certifications



Dimensions

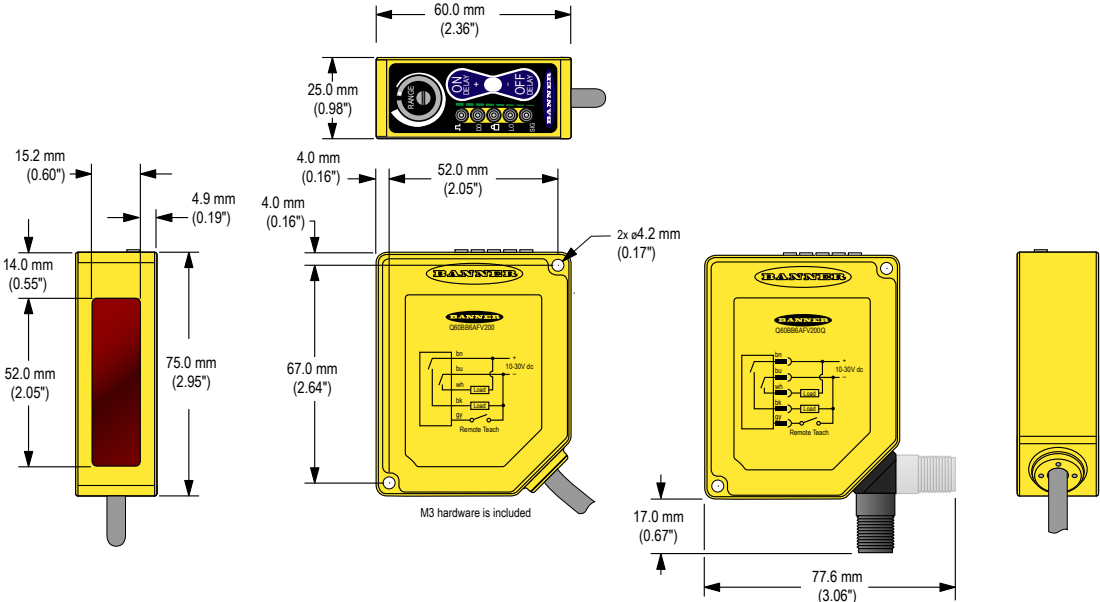

Performance Curves

Performance is based on a 90% reflectance white test card.

Class 1 Laser Models—Excess Gain at 200 mm and 1200 mm Cutoff

Class 2 Laser Models—Excess Gain at 1200mm and 2000 mm Cutoff

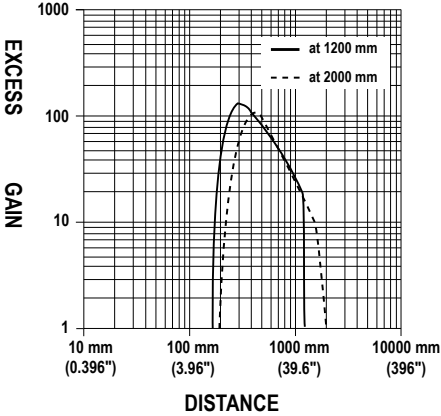
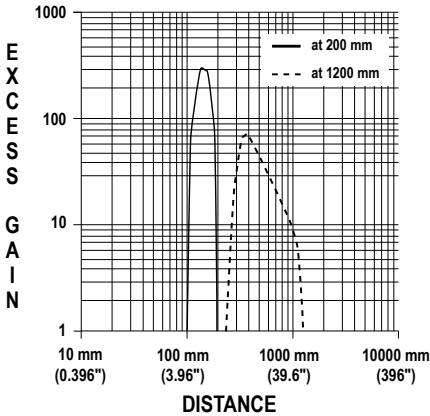

Accessories

Cordsets

4-Pin Micro-Style Cordsets				
Model	Length	Style	Dimensions	Pinout (Female)
MQAC-406	1.83 m (6 ft)	Straight		<p>1 = Red/Black 2 = Red/White 3 = Red 4 = Green</p>
MQAC-415	4.57 m (15 ft)			
MQAC-430	9.14 m (30 ft)			
MQAC-406RA	1.83 m (6 ft)	Right-Angle		
MQAC-415RA	4.57 m (15 ft)			
MQAC-430RA	9.14 m (30 ft)			

5-Pin Threaded M12/Euro-Style Cordsets—Single Ended				
Model	Length	Style	Dimensions	Pinout (Female)
MQDC1-501.5	0.50 m (1.5 ft)	Straight		<p>1 = Brown 2 = White 3 = Blue 4 = Black 5 = Gray</p>
MQDC1-506	1.83 m (6 ft)			
MQDC1-515	4.57 m (15 ft)			
MQDC1-530	9.14 m (30 ft)	Right-Angle		
MQDC1-506RA	1.83 m (6 ft)			
MQDC1-515RA	4.57 m (15 ft)			
MQDC1-530RA	9.14 m (30 ft)			

Brackets

SMBQ60

- Right-angle bracket
- 14-ga., 304 Stainless Steel

